

E Pluribus Unum: Melding Manifold Metadata for Use in a Consortial Setting

Tracy Seneca
University of Illinois at Chicago

Charles Blair
University of Chicago



We'll cover

- The CCC: who we are
- The current challenge for researchers
- The Chicago Portal: our vision
- Challenges for the CCC
- The technology selection
- Our approach: the Metadata Hopper

The Chicago Collections Consortium



ROOSEVELT UNIVERSITY



NORTHWESTERN UNIVERSITY LIBRARY



Northern Illinois University



Preparing people to lead extraordinary lives

The Challenge for Researchers

John T. McCutcheon Collections

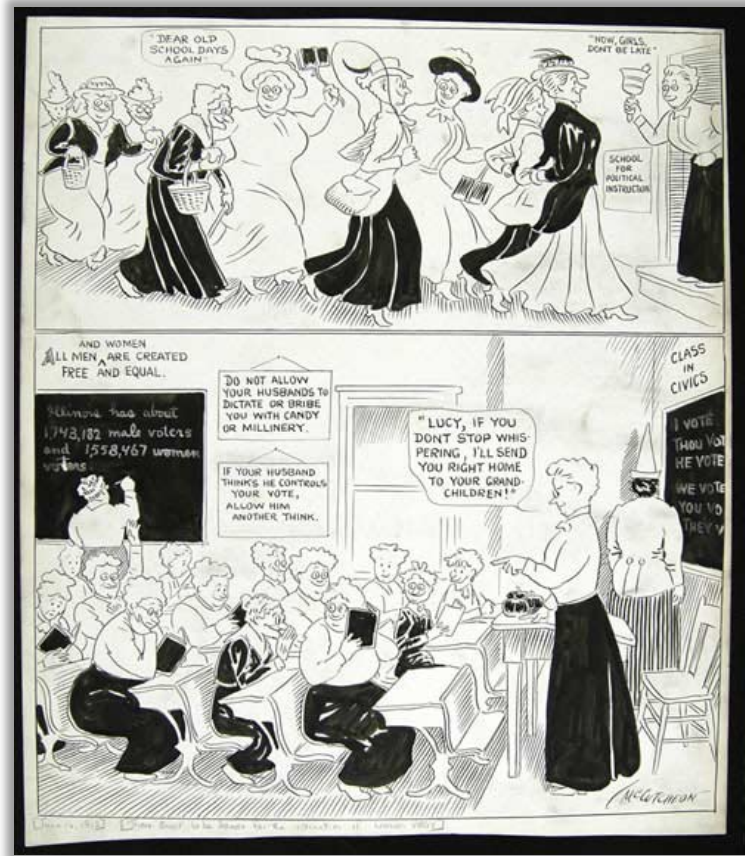

Chicago History
Museum

Newberry Library

University of Illinois at
Chicago

John T. McCutcheon, "There Ought to be School for Women Voters," 1913, Newberry Library Collection

Pullman Collections

Chicago Public Library
Newberry Library
Chicago History Museum
Art Institute of Chicago

EMPLOYED	RESIGNED	DISCHARGED	TRANSFERRED	DISTRICT	REASON
7 20 29				CW	9/28 Book
					Reinstated 7/12/29
					Ret. for 5/23/29
					Transf. for service 11/12/29
					Transf. for 5/10/30
					Transf. for 11/12/29
					Transf. for 5/10/30
					Transf. for 11/12/29
					Transf. for 5/10/30

IDENT. KEY NO. [Handwritten]

LOSS RECORD

NAME [Handwritten]

THE PULLMAN PRESS, CHICAGO, U.S.A.

Pullman, Employee Service Record, Phillips, Newberry Library Collection

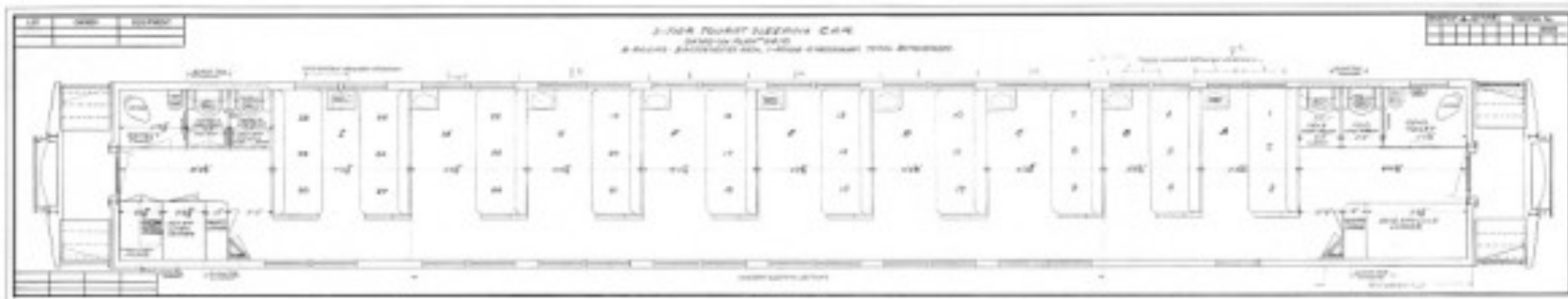

An engineer drawing of a Pullman Company Three-Tier Tourist Sleeping Car, 1906, Newberry Library Pullman Digital Collection

Century of Progress

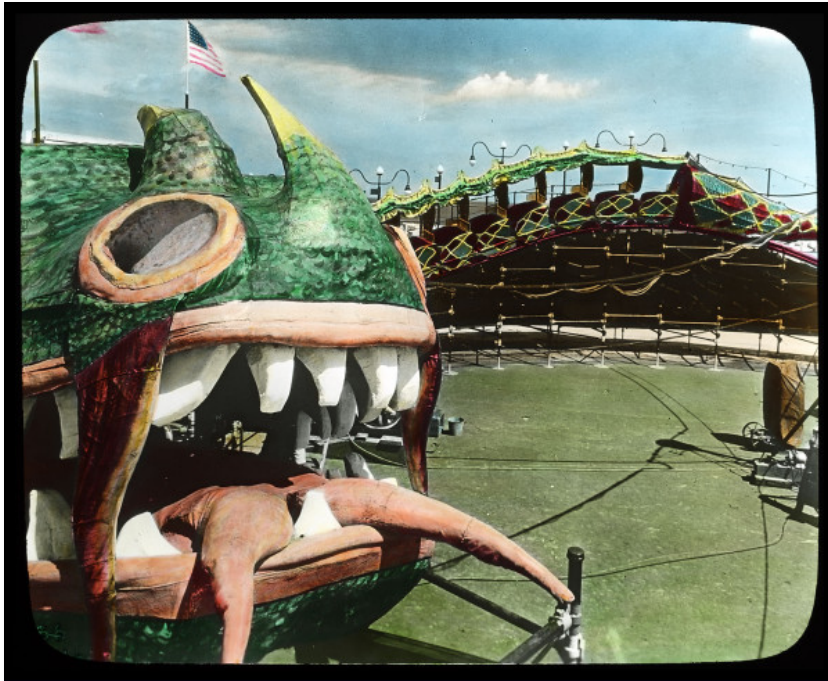

All rights reserved, University of Illinois at Chicago Library.

*Amusement rides at A Century of Progress Enchanted Island.
UIC Collections.*



*Century of Progress - General Motors Building.
Art Institute of Chicago*

Libraries throughout Chicago ask:

How do we open up our archives and digital collections to Chicago researchers?

We did all this work to write finding aids, create collection records and digitize but nobody knows what's in our archives.

Chicago Portal: The Vision

- **Depth** of access
- Chicago focus
- Accessible to the novice but supports the seasoned researcher

*Scheduled for August 2015 release
Thanks to Andrew W. Mellon Foundation*

Chicago Portal: Scope

- ~ 1,500 EAD finding aids
- Hundreds of PDF finding aids with associated MARC
- ~ 2,000 collection level MARC records
- ~150,000 digital images
 - Custom CONTENTdm
 - MARC

Our Challenges

How do you express a name?

ead/archdesc/controlaccess/controlaccess/persname

ead/archdesc/controlaccess/controlaccess/corpname

ead/archdesc/controlaccess/controlaccess/famname

ead/archdesc/did/origination/famname

ead/archdesc/did/origination/corpname

ead/archdesc/did/origination/persname

ead/archdesc/descgrp/controlaccess/persname

ead/archdesc/descgrp/controlaccess/corpname

ead/archdesc/descgrp/controlaccess/famname

ead/archdesc/controlaccess/corpname

ead/archdesc/controlaccess/famname

ead/archdesc/controlaccess/persname

ead/archdesc/controlaccess/p/famname

ead/archdesc/controlaccess/p/corpname

ead/archdesc/controlaccess/p/persname

ArchitectDesignerCreator

AdditionalArchitectOrDesigner

ProjectPersonnel

Creator

creator

Photographers

Photographer

14,730 subject terms (9,810 only ever used once)

Balloon framing

Burlesque (Theater) --

Burlesque (Theater --

Hack writers

Murgatroyd, Everett F., 1880 or 1-1946.

one way streets

Painting.

Paintings

Radio -- Illinois -- Chicago Metropolitan Area -- Receivers and reception -- 1980-1989. -- lctgm

tree

Trees -- Chicago Metropolitan Area -- 1900-1919. -- lctgm

Weather experiments

Xylophone -- Instruction and study

Assume

- No one is going to adjust their local standards or practices
- No one is going to maintain a second version of metadata for the CCC

Don't Assume

- That we can just point to CCC members' image records – some have digital images with no discovery platform

CCC Portal Technology Choice

XTF (eXtensible Text Framework)

Reason 1

Flexible metadata processing

Reason 2

XTF allows variation

Reason 3

XTF allows full-text searching across
all documents

Reason 4

A dc.xml “side-car” file accompanies
each document

Reason 5

XTF works out of the box to index,
search and display. Yet ...

Reason 6

XTF can easily be turned into a client/
server solution

Reason 7

Support

(<http://xtf.cdlib.org>)

Test Data Set: Minimal Processing

XTF has been optimized to recognize metadata element mapping, but none of Hopper's dc.xml files are included.

Search: **Image** in type [X]

Results: 881 Items

Sorted by:

[Modify Search](#) | [New Search](#)

[Browse by Facet](#) | [Title](#) | [Author](#)

Page: [1](#) [2](#) [3](#) [4](#) [5](#) ... [Next](#)

- Subject**
- less*
 - [14th Street Yard \(Chicago, Ill.\)](#) (14)
 - [Adler and Sullivan.](#) (1)
 - [Adler, Dankmar, 1844-1900.](#) (1)
 - [Advertisements.](#) (1)
 - [Aerial views](#) (4)
 - [African Americans -- Chicago -- Illinois](#) (1)
 - [African Americans -- Colorado -- Denver](#) (1)
 - [African Americans -- Illinois -- Chicago](#) (3)
 - [African Americans -- Nebraska -- Lincoln](#) (1)
 - [African-Americans -- Illinois -- Chicago](#) (2)
 - [Air conditioning](#) (2)
 - [Air-brakes](#) (1)
 - [Alleys](#) (3)



Title: [Borden Block](#)
Description: Levy #690. Demolished 1917.
Date: 1881
Subjects: [D. Adler & Co.](#) | [Adler and Sullivan.](#) | [Adler, Dankmar, 1844-1900.](#) | [Sullivan, Louis H., 1856-1924.](#) | [Stores, Retail.](#) | [Commercial buildings.](#) | [Architecture--Illinois--Chicago.](#) | [Loop \(Chicago, Ill.\)](#)



Title: [Ellsworth Building](#)
Description: [p. 9 of 163].
Date: 1986
Subjects: [Van Osdel, John M., 1811-1891.](#) | [Van Osdel & Co.](#) | [Harry Weese and Associates.](#) | [Office buildings.](#) | [Skyscrapers.](#) | [Architecture--Illinois--Chicago.](#) | [Loop \(Chicago, Ill.\)](#)



Title: [Ellsworth Building](#)
Description: [p. 18 of 163].
Date: 1892
Subjects: [Van Osdel, John M., 1811-1891.](#) | [Van Osdel & Co.](#) | [Harry Weese and Associates.](#) | [Young & Farrel Diamond Stone Sawing Co.](#) | [Office buildings.](#) | [Skyscrapers.](#) | [Architecture--Illinois--Chicago.](#) | [Loop \(Chicago, Ill.\)](#) | [Advertisements.](#)

Coverage

less

- [1514 S. Michigan Ave. \[?\]](#) (1)
- [1948](#) (199)
- [2505 S. Michigan Ave.](#) (1)
- [2727 N. Hampden Ct.](#) (1)
- [39.755089, -104.988105](#) (9)
- [40.807701, -91.124793](#) (10)
- [40.813628, -96.70262](#) (5)
- [40.819008, -91.178](#) (21)
- [40.849678, -96.63443](#) (29)
- [40.936949, -94.896042](#) (6)
- [40.947522, -90.37819](#) (12)
- [41.061029, -94.364989](#) (6)
- [41.259751, -95.942363](#) (2)
- [41.605955, -87.534554](#) (1)
- [41.615121, -87.510218](#) (1)
- [41.617363, -87.513708](#) (1)
- [41.619708, -87.519809](#) (1)
- [41.620842, -87.52251](#) (1)
- [41.622195, -87.525006](#) (1)
- [41.739266, -87.541035](#) (1)
- [41.759799, -87.827456](#) (1)
- [41.76057, -88.320209](#) (23)
- [41.772273, -87.619641](#) (1)
- [41.777956, -87.589595](#) (1)

Title: [Mildred B. Bevis Notebook of Designs for the Kalo Shop,](#)
Description: The notebook contains Arts and Crafts-influenced jewelry and tableware designs by Mildred Belle Bevis Hanks for the Kalo Shop in Chicago, Illinois.
Date: 1913
Subjects: [Art metal-work--Illinois--Chicago](#)

Title: [Dankmar Adler \(1844-1900\) Collection,](#)
Description: Papers and photographs related to the life and work of Chicago structural engineer Dankmar Adler, partner of architect Louis H. Sullivan.
Date: 1941
Subjects: [Chicago Auditorium Building \(Chicago, Ill.\) | Architecture--Illinois--Chicago--19th century--Sources | Architecture--Illinois--Chicago--20th century--Sources | Architects--Illinois--Chicago--Archives](#)

Title: [Fazlur R. Khan \(1929-1982\) Collection,](#)
Description: This collection holds professional papers and writings and a small group of personal papers of the Bangladeshi structural engineer Fazlur R. Khan.
Date: 1988
Subjects: [John Hancock Center \(Chicago, Ill.\) | Sears Tower \(Chicago, Ill.\) | Skyscrapers--Designs and plans | Structural engineering | Engineering design](#)

Title: [Peter J. Weber \(1863-1923\) Papers,](#)
Description: Photographs, correspondence, and printed matter documenting a selection of German-American architect Peter J. Weber's built and unbuilt projects in the United States and abroad,

And...

XTF doesn't have an administrative
interface

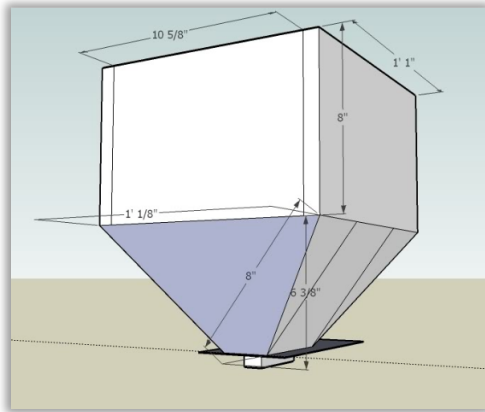

The Metadata Hopper

- Archivist/Librarian signs in
- Create a metadata map
- Add files
- Tag records (choose browsing facets)

Deposit: Create Import Rules (Metadata Map)

Art Institute of Chicago
Digital Image Collection

- Overview
- Deposit
- Tag
- Connect
- Preview
- Publish
- Search & Browse
- User Guide

Overview

Art Institute of Chicago

Metadata Hopper lets you deposit content to the Chicago Collections Consortium portal, control how your content is discovered in the portal, and connect related content in the portal. If you need help getting started, use the Quick Help and Tips text in the right-hand sidebar.

Your Content

Profile	Deposited	Previewed	Published
AIC EAD Finding Aids	159	0	0

Your Chicago Collections Consortium Users

Administrator: Tracy Seneca
 Archivists: 1

Quick Help

- [Quick Start](#)
- [Demo Videos](#)
- [FAQ](#)

Tips

- Choose [Deposit & Update](#) to add new or re-deposit content
- Choose [Tag](#) to control where your objects appear in the portal
- Choose [Connect](#) to connect related objects
- Choose [Preview](#) to see what your new content will look like in the portal
- Choose [Publish](#) to make new content available in the public portal
- Use [Search](#) to take any of these actions with a particular object or set of objects



Metadata Hopper

Chicago Collections Consortium

- Overview
- Deposit
- Tag
- Connect
- Preview
- Publish
- Search & Browse
- User Guide

Tracy Seneca - Art Institute of Chicago

Finder window titled "aic-images" showing a file list:

.DS_Store	000000_100622-15.jpg
aic-images	000000_100622-15.xml
Imported	000000_120210_009.jpg
newberry-ead	000000_120210_009.xml
stash	000000_120210_018.jpg
xtfWorkshop(1)	000000_120210_018.xml
	000000_120210_019.jpg
	000000_120210_019.xml
	000000_120210_091.jpg
	000000_120210_091.xml
	IA1802_0796.jpg
	IA1802_0796.xml
	U525784.jpg
	U525784.xml
	U525789.jpg
	U525789.xml

Quick Help

- Quick Start
- Demo Videos
- FAQ

Tips

- Choose **Deposit & Update** to add new or re-deposit content
- Choose **Tag** to control where your objects appear in the portal
- Choose **Connect** to connect related objects
- Choose **Preview** to see what your new content will look like in the portal
- Choose **Publish** to make new content available in the public portal
- Use **Search** to take any of these actions with a particular object or set of objects



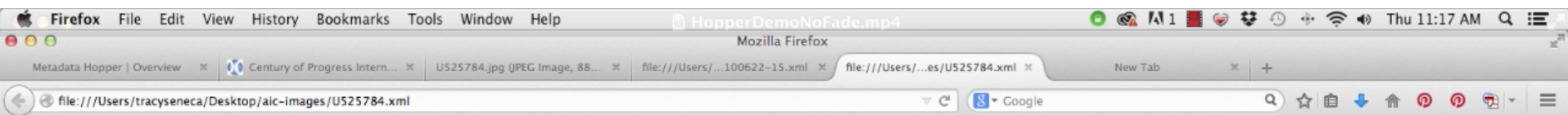

This XML file does not appear to have any style information associated with it. The document tree is shown below.

```
- <record>
- <TitleProjectName>
  Century of Progress International Exposition, General Motors Building
  </TitleProjectName>
  <AlternateTitleProjectName/>
  <StreetAddressNeighborhood/>
  <City>Chicago</City>
  <StateProvince>Illinois</StateProvince>
  <Country>United States</Country>
  <DateDesignedOrBuilt>1932-1933</DateDesignedOrBuilt>
  <ExhibitionDate/>
  <MembershipDates/>
  <IllustrationDates/>
  <ArchitectDesignerCreator>Kahn, Albert</ArchitectDesignerCreator>
  <AdditionalArchitectOrDesigner/>
  <ArchitectOrDesignerNotes/>
  <ProjectPersonnel>Milles, Carl [sculptor]</ProjectPersonnel>
  <ProjectPersonnelNotes/>
  <BuildingStyle/>
  <BuildingType/>
  <DateOfView/>
  <DateOfObject/>
  <ViewOrDetailType>Exterior</ViewOrDetailType>
  <ImageNotes/>
  <DuplicateStaffNote/>
  <CaptionInscriptionText/>
  <PrintCaptions/>
  <InscriptionLocation/>
  <Photographers/>
  <DigitalCollectionName>Archival Image Collection</DigitalCollectionName>
- <ArchivalCollectionName>
  Historic Architecture and Landscape Image Collection
```



Firefox File Edit View History Bookmarks Tools Window Help HopperDemoNoFade.mp4
U525784.jpg (JPEG Image, 882 x 1056 pixels) - Scaled (66%)
Metadata Hopper | Overview x Century of Progress Intern... x U525784.jpg (JPEG Image, 88... x file:///Users/...100622-15.xml x file:///Users/...es/U525784.xml x New Tab x +
file:///Users/tracyseneca/Desktop/aic-images/U525784.jpg Google



A Mac OS X dock containing various application icons. From left to right, the icons include: a blue square with a white 'S', a silver rocket, a blue square with a white '@', a calendar icon showing the number '4', a yellow notepad, a keyboard, a blue square with a white palm tree, a blue square with a white bar chart, a red circle with a white musical note, a black square with a white play button, a blue circle with a white 'A', a blue square with a white gear, a blue square with a white mouse cursor, a blue circle with a white gear, a blue circle with a white globe, a blue square with a white 'a', a blue 'W', a red 'P', a green 'X', a blue square with a white 'H', a green square with a white 'C', a black square with a white 'C', a black square with a white 'C', a white square with a blue 'C', and a silver trash can.

- Overview
- Deposit
- Tag
- Connect
- Preview
- Publish
- Search & Browse
- User Guide

Deposit & Replace

- Digital Images
- Archival Collections

- Create new deposit rules for:
- Digital Images: separate XML files
 - Digital Images: using a single XML file

Quick Help

- Quick Start
- Demo Videos
- FAQ

Tips

If you want to create a rule set for a metadata format that does not appear here, please [contact the portal manager](#).



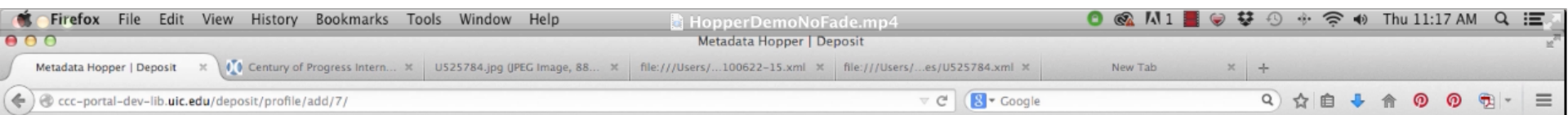

- Overview
- Deposit**
- Tag
- Connect
- Preview
- Publish
- Search & Browse
- User Guide

Create Import Mapping Rules: Digital Images

Step 1 of 5: Prepare

You will be asked to identify which fields contain each record's title and other elements. You can also use one of the [import mapping rules worksheets](#) to help you build your import rules or have a record open for review. You will also need one sample file that contains all the element paths or fields you've identified. This file will be used as a test to make sure what you've specified is correct and will be discarded after tested.

Click **next** to start building your import rules.

Quick Help

- [Quick Start](#)
- [Demo Videos](#)
- [FAQ](#)

Tips

The [portal manager](#) can help you set up new import rules. Find out more about [sample files](#).



- Overview
- Deposit
- Tag
- Connect
- Preview
- Publish
- Search & Browse
- User Guide

Create Import Mapping Rules: Digital Images

Step 2 of 5: Name & Describe

Name:

Displays to the user to help select the correct rules for deposit

Description:

Describe your import mapping rules.

- Quick Help
- Quick Start
 - Demo Videos
 - FAQ



- Overview
- Deposit
- Tag
- Connect
- Preview
- Publish
- Search & Browse
- User Guide

Create Import Mapping Rules: Digital Images

Step 3 of 5: Submit a sample file

Please submit a sample metadata file. When you specify your fields in the next screen, you will have a chance to test each path against what is in the sample file you submitted.

This sample file should have values for all element paths you will specify in your rules. If you don't have a file that has values for all element paths, feel free to create a file that has values for all element paths.

The sample file you use will not be added to your portal content, and can contain dummy data.

Sample file:

U525784.xml

Quick Help

- Quick Start
- Demo Videos
- FAQ



- Overview
- Deposit
- Tag
- Connect
- Preview
- Publish
- Search & Browse
- User Guide

Test

Image suffix

The metadata file for each image must contain the file name of the corresponding image.
Suffix:

Image submission

Will you be submitting image files?

Back Cancel Next

Quick Help

- Quick Start
- Demo Videos
- FAQ

Tips

For the record separator form, if your record looks like this:

```
<metadata>
  <record>
    <title>
      Title1
    </title>
  </record>
  <record>
    <title>
      Title2
    </title>
  </record>
</metadata>
```

Type **record** into the Source element field.



- Overview
- Deposit
- Tag
- Connect
- Preview
- Publish
- Search & Browse
- User Guide

Create Import Mapping Rules: Digital Images

Step 5 of 5: Define Import Fields

*** Title**

The element that is the source for each object's title.

Source element:

Title (subtitle)

This will be appended to the end of the title. Example - Title: Subtitle

Source element:

Instance:

Quick Help

- Quick Start
- Demo Videos
- FAQ

Tips

- ✓ Indicates that your test has completed successfully
- ✗ Indicates that an error occurred with your test. Look next to the ✗ to see the specific error.



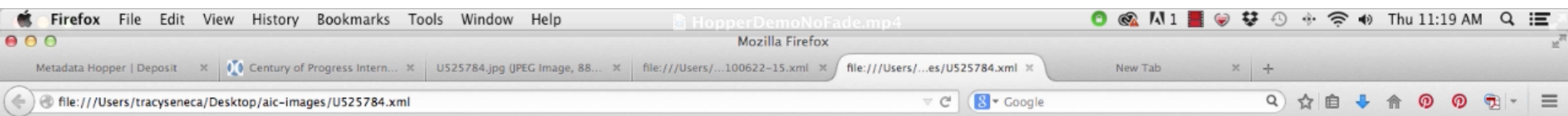

This XML file does not appear to have any style information associated with it. The document tree is shown below.

```
- <record>
- <TitleProjectName>
  Century of Progress International Exposition, General Motors Building
</TitleProjectName>
<AlternateTitleProjectName/>
<StreetAddressNeighborhood/>
<City>Chicago</City>
<StateProvince>Illinois</StateProvince>
<Country>United States</Country>
<DateDesignedOrBuilt>1932-1933</DateDesignedOrBuilt>
<ExhibitionDate/>
<MembershipDates/>
<IllustrationDates/>
<ArchitectDesignerCreator>Kahn, Albert</ArchitectDesignerCreator>
<AdditionalArchitectOrDesigner/>
<ArchitectOrDesignerNotes/>
<ProjectPersonnel>Milles, Carl [sculptor]</ProjectPersonnel>
<ProjectPersonnelNotes/>
<BuildingStyle/>
<BuildingType/>
<DateOfView/>
<DateOfObject/>
<ViewOrDetailType>Exterior</ViewOrDetailType>
<ImageNotes/>
<DuplicateStaffNote/>
<CaptionInscriptionText/>
<PrintCaptions/>
<InscriptionLocation/>
<Photographers/>
<DigitalCollectionName>Archival Image Collection</DigitalCollectionName>
- <ArchivalCollectionName>
  Historic Architecture and Landscape Image Collection
```



- Overview
- Deposit
- Tag
- Connect
- Preview
- Publish
- Search & Browse
- User Guide

Create Import Mapping Rules: Digital Images

Step 5 of 5: Define Import Fields

*** Title**

The element that is the source for each object's title.

Source element:

record/TitleProjectName

✓ Century of Progress International Exposition, General Motors Building

Test

Title (subtitle)

This will be appended to the end of the title. Example - Title: Subtitle

Source element:

- Quick Help**
- Quick Start
 - Demo Videos
 - FAQ
- Tips**
- ✓ Indicates that your test has completed successfully
 - ✗ Indicates that an error occurred with your test. Look next to the ✗ to see the specific error.



- Overview
- Deposit
- Tag
- Connect
- Preview
- Publish
- Search & Browse
- User Guide

Subject

The source for subject terms. These will be searchable and may be used to automatically apply tags in the public portal.

Source element:
record/SubjectTerms

Instance:
All

Has delimiter:
Yes

Delimiter:
;

✓ Kahn, Albert, 1869-1942., Milles, Carl, 1875-1955., Fairs., Century of Progress International Exposition (1933-1934 : Chicago, Ill.), Architecture--Illinois--Chicago.

Test

Add another

Quick Help

- Quick Start
- Demo Videos
- FAQ

Tips

- ✓ Indicates that your test has completed successfully
- ✗ Indicates that an error occurred with your test. Look next to the ✗ to see the specific error.



We're mapping:

- Title (*required*)
- Subtitle
- Title (date – for EAD)
- Dates
- Local Identifier
- Description
- Names
- Subject
- Geographic Coverage
- Source Archival Collection (for images)
- Digital Collection Name (for images)
- Digital Collection URL (for images)
- Rights

- Overview
- Deposit
- Tag
- Connect
- Preview
- Publish
- Search & Browse
- User Guide

Create Import Mapping Rules: Digital Images

Confirmation - Rules Created

Use [AIC Images](#) to add a new batch of records.

Rule set saved:

- Name**
AIC Images
- Description**
Images from AIC CONTENTdm
- Image filename**
Path: record/RBADigitalFileName
- Image suffix**
Suffix:
- Title**
Path: record/TitleProjectName
- Title (subtitle)**
[Not mapped]
- Dates**

Quick Help

- Quick Start
- Demo Videos
- FAQ



Tagging: Simplify Topical Browsing

Newberry Library

Tag a Batch of Records

- Overview
- Deposit
- Tag
- Connect
- Preview
- Publish
- Search & Browse
- User Guide

Overview

Newberry Library

Metadata Hopper lets you deposit content to the Chicago Collections Consortium portal, control how your content is discovered in the portal, and connect related content in the portal. If you need help getting started, use the Quick Help and Tips text in the right-hand sidebar.

Your Content

Profile	Deposited	Previewed	Published
Daily Life Along the CB&Q	199	0	0
Newberry EAD	0	0	0

Your Chicago Collections Consortium Users

Administrator: No Admin
Archivists: 0

Quick Help

- Quick Start
- Demo Videos
- FAQ

Tips

- Choose [Deposit & Update](#) to add new or re-deposit content
- Choose [Tag](#) to control where your objects appear in the portal
- Choose [Connect](#) to connect related objects
- Choose [Preview](#) to see what your new content will look like in the portal
- Choose [Publish](#) to make new content available in the public portal
- Use [Search](#) to take any of these actions with a particular object or set of objects



- Overview
- Deposit
- Tag**
- Connect
- Preview
- Publish
- Search & Browse
- User Guide

Tag

Use the dropdown to view a list of objects with selected tags.
You can also use the dropdown to remove tags from all objects with the selected tag.

Select status Select type

Browse by Tags Browse by Original Metadata

- Chicago Topics (6)
- Cities (128)

Quick Help

- Quick Start
- Demo Videos
- FAQ

Tips

Browse by Tags refers to tags added both automatically and manually to an object.
Use Browse by Original Metadata to browse by the metadata submitted with the object.



- Overview
- Deposit
- Tag
- Connect
- Preview
- Publish
- Search & Browse
- User Guide

Tag

Use the dropdown to view a list of objects with selected tags.
You can also use the dropdown to remove tags from all objects with the selected tag.

Select status Select type

- Browse by Tags
- Browse by Original Metadata

- Local identifier (597)
- Names (199)
- Subject (710)
- Title (199)
- Geographic coverage (591)
- Source archival collection (199)
- Rights (199)
- Description (199)
- Dates (199)

Quick Help

- Quick Start
- Demo Videos
- FAQ

Tips

Browse by Tags refers to tags added both automatically and manually to an object.

Use Browse by Original Metadata to browse by the metadata submitted with the object.



- Overview
- Deposit
- Tag
- Connect
- Preview
- Publish
- Search & Browse**
- User Guide

Browse imported records by field: "Source archival collection"

This view contains your original metadata.

Select status Select type Source archival collection starts with contains Enter search terms Limit

One result sort by value | count

Select All (on this page)

Chicago, Burlington & Quincy Railroad Company Archives (199 records)

- Quick Help
- Quick Start
 - Demo Videos
 - FAQ

Waiting for ccc-portal-staging-lib.uic.edu...



- Overview
- Deposit
- Tag
- Connect
- Preview
- Publish
- Search & Browse
- User Guide

- Entertainment and Popular Culture
- Ethnic and Cultural Groups
- Families
- Gender and Sexuality
- Law
- Literature and Poetry
- Medicine and Health
- Military and Wars
- Music
- Philanthropy
- Police and Firefighters
- Politics
- Printing History and Book Art
- Religion
- Science and Technology
- Social Justice
- Social Service
- Sports and Recreation
- Theater and Performing Arts
- Transportation
- Tourism
- Women

Submit Cancel

Quick Help

- Quick Start
- Demo Videos
- FAQ



- Overview
- Deposit
- Tag
- Connect
- Preview
- Publish
- Search & Browse
- User Guide

Tags added

Chicago Topics "Transportation" added to Armature repair department of Diesel shop

Chicago Topics "Transportation" added to Girl eating ice cream cone, Creston, Iowa

Chicago Topics "Transportation" added to Union Station--view of concourse showing information desk

Chicago Topics "Transportation" added to Building part of boxcar in a jig, Havelock, Nebraska

Chicago Topics "Transportation" added to Filling journal boxes with oil at car repair tracks

Chicago Topics "Transportation" added to Commuters waiting for suburban train

Chicago Topics "Transportation" added to Union Station--passengers waiting to board train

Chicago Topics "Transportation" added to Locomotive repair shops

Chicago Topics "Transportation" added to Filling journal boxes with oil at car repair tracks

Chicago Topics "Transportation" added to Union Station--passengers waiting to board train

Chicago Topics "Transportation" added to Members of extra gang

Chicago Topics "Transportation" added to Union Station--in the waiting room

Chicago Topics "Transportation" added to Trainman

Chicago Topics "Transportation" added to Hinsdale Station--Early morning commuters waiting

Chicago Topics "Transportation" added to Locomotive being repaired in roundhouse

Chicago Topics "Transportation" added to Union Station--passengers at phone booth in concourse

Chicago Topics "Transportation" added to Girls talking in business district, Creston, Iowa

Chicago Topics "Transportation" added to Cutting steel with acetylene torch at shops

Quick Help

- Quick Start
- Demo Videos
- FAQ



- Overview
- Deposit
- Tag
- Connect
- Preview
- Publish
- Search & Browse
- User Guide

Tag

Chicago Topics

Select status Select type Assigned by Limit

Four results sort by value | count

Select All (on this page) Review Delete Cancel

- Women (3 Records)
- Children And Teenagers (2 Records)
- Transportation (199 Records)
- Families (1 Records)

Quick Help

- Quick Start
- Demo Videos
- FAQ



Tagging: Autotag upon Deposit

Newberry Library

EAD Finding Aids

- Overview
- Deposit
- Tag
- Connect
- Preview
- Publish
- Search & Browse
- User Guide

Overview

Newberry Library

Metadata Hopper lets you deposit content to the Chicago Collections Consortium portal, control how your content is discovered in the portal, and connect related content in the portal. If you need help getting started, use the Quick Help and Tips text in the right-hand sidebar.

Your Content

Profile	Deposited	Previewed	Published
Daily Life Along the CB&Q	199	0	0
Newberry EAD	0	0	0

Your Chicago Collections Consortium Users

Administrator: No Admin
Archivists: 0

Quick Help

- Quick Start
- Demo Videos
- FAQ

Tips

- Choose [Deposit & Update](#) to add new or re-deposit content
- Choose [Tag](#) to control where your objects appear in the portal
- Choose [Connect](#) to connect related objects
- Choose [Preview](#) to see what your new content will look like in the portal
- Choose [Publish](#) to make new content available in the public portal
- Use [Search](#) to take any of these actions with a particular object or set of objects





Updates Available

Your computer will restart to complete these updates.

Details

Restart

Metadata Hopper

Chicago Collections Consortium

Tracy Seneca - Newberry Library

Overview

Deposit

Tag

Connect

Preview

Publish

Search & Browse

User Guide

Deposit & Replace

Digital Images

Archival Collections

Use existing deposit rules for:

- [Newberry EAD](#)

Create new deposit rules for:

- [Archival Collections: EAD](#)

Quick Help

- Quick Start
- Demo Videos
- FAQ

Tips

If you want to create a rule set for a metadata format that does not appear here, please [contact the portal manager](#).



- Overview
- Deposit
- Tag
- Connect
- Preview
- Publish
- Search & Browse
- User Guide

Add New Content: Newberry EAD

Step 1 of 2

Description:

EAD format for Newberry

Rules:

Title

Path: ead/frontmatter/titlepage/titleproper

Title (subtitle)

[Not mapped]

Title (date)

Path: ead/frontmatter/titlepage/titleproper/date

Dates

Path: ead/frontmatter/titlepage/titleproper/date

Local identifier

Path: ead/eadheader/eaidid

Quick Help

- Quick Start
- Demo Videos
- FAQ



- Overview
- Deposit**
- Tag
- Connect
- Preview
- Publish
- Search & Browse
- User Guide

Add New Content: Newberry EAD

Step 2 of 2

Click "Select files" then browse to the directory on your local drive that contains the files you are depositing.

Back Cancel Finish

+ Add files... Start upload

Quick Help

- Quick Start
- Demo Videos
- FAQ



- FAVORITES
- Dropbox
 - All My Files
 - Applications
 - Desktop
 - Documents
 - Downloads
 - Creative Cloud Files
 - Box Sync
- DEVICES
- Remote Disc
- SHARED
- linksys16926
- MEDIA
- Music
 - Photos
 - Movies
- TAGS
- Red
 - Orange
 - Yellow
 - Green
 - Blue
 - Purple
 - Gray
 - All Tags...

Desktop

Folders	Date Modified	Size	Kind
xtfWorkshop(1)	8/11/14	--	Folder
Imported	Yesterday	--	Folder
newberry-eac	10:43 AM	--	Folder
stash	10:44 AM	--	Folder



- FAVORITES
 - Dropbox
 - All My Files
 - Applications
 - Desktop
 - Documents
 - Downloads
 - Creative Cloud Files
 - Box Sync
- DEVICES
 - Remote Disc
- SHARED
 - linksys16926
- MEDIA
 - Music
 - Photos
 - Movies
- TAGS
 - Red
 - Orange
 - Yellow
 - Green
 - Blue
 - Purple
 - Gray
 - All Tags...

Developer	Date Modified	Size	Kind
Kaster.xml	10/19/13	83 KB	XM...ent
relocation.xml	10/19/13	25 KB	XM...ent
ReynoldsMcBride.xml	10/19/13	44 KB	XM...ent
RiceW.xml	10/19/13	60 KB	XM...ent
Rizzo.xml	10/19/13	28 KB	XM...ent
Roden.xml	10/19/13	27 KB	XM...ent
Rogers.xml	10/19/13	71 KB	XM...ent
Rowley.xml	10/19/13	10 KB	XM...ent
Royko.xml	10/19/13	107 KB	XM...ent
Ruff.xml	10/19/13	67 KB	XM...ent
Sagan.xml	10/19/13	20 KB	XM...ent
SeeingIndian.xml	10/19/13	45 KB	XM...ent
Seymour.xml	10/19/13	29 KB	XM...ent
ShawFW.xml	10/19/13	52 KB	XM...ent
Sherman.xml	10/19/13	21 KB	XM...ent
Sherwood.xml	10/19/13	14 KB	XM...ent
Shorey.xml	10/19/13	10 KB	XM...ent
Singer.xml	10/19/13	24 KB	XM...ent
Sloan.xml	10/19/13	23 KB	XM...ent
SmithHJ.xml	10/19/13	27 KB	XM...ent
SpiegelHemingway.xml	10/19/13	16 KB	XM...ent
SpiegHemC.xml	10/19/13	22 KB	XM...ent
Stevenson.xml	10/19/13	81 KB	XM...ent
Stigler.xml	10/19/13	19 KB	XM...ent
Stock.xml	10/19/13	27 KB	XM...ent
Stonej.xml	10/19/13	11 KB	XM...ent
Stowe.xml	10/19/13	26 KB	XM...ent
Strong.xml	10/19/13	60 KB	XM...ent
Tallmadge.xml	10/19/13	20 KB	XM...ent
Thomas.xml	10/19/13	88 KB	XM...ent
TiaChucha.xml	10/19/13	38 KB	XM...ent
TietjensAdditions.xml	10/19/13	55 KB	XM...ent
TroyFarrell.xml	10/19/13	22 KB	XM...ent
Trumbull.xml	10/19/13	59 KB	XM...ent
Turbyfill.xml	10/19/13	29 KB	XM...ent
Valentine.xml	10/19/13	28 KB	XM...ent



- Overview
- Deposit
- Tag
- Connect
- Preview
- Publish
- Search & Browse
- User Guide

Add New Content: Newberry EAD

Step 2 of 2

Click "Select files" then browse to the directory on your local drive that contains the files you are depositing.

Back Cancel Finish

+ Add files... Start upload

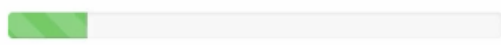

2.12 Mbit/s | 00:00:07 | 20.33 % | 496.86 KB / 2.44 MB

files uploaded: 10

McNickle.xml	99.41 KB	Remove
Meeker.xml	41.43 KB	Remove
Mencken.xml	9.90 KB	Remove
Monroe.xml	8.46 KB	Remove
Montezuma.xml	76.64 KB	Remove

Quick Help

- Quick Start
- Demo Videos
- FAQ



- Overview
- Deposit
- Tag
- Connect
- Preview
- Publish
- Search & Browse
- User Guide

Add New Content: Newberry EAD

Processing deposit...

Your files have been received by Metadata Hopper and we are currently processing them. You will be sent an email confirmation once the deposit has been completed.

Continue uploading files with [Newberry EAD](#)

Upload files with different rules:

- #### Quick Help
- Quick Start
 - Demo Videos
 - FAQ



Current Folder: INBOX



[UIC WebMail FAQ](#)

[Search Results](#) | [Unread](#) | [Delete](#)

[Forward](#) | [Forward as Attachment](#) | [Reply](#) | [Reply All](#)

Subject: Chicago Collections Consortium Deposit Completed (0 errors)
From: ccc.portal.notifications@gmail.com
Date: Tue, December 2, 2014 10:17 pm
To: tjseneca@uic.edu ([more](#))
Priority: Normal
Options: [View Full Header](#) | [View Printable Version](#) | [Download this as a file](#) | [View Message Details](#) | [Add to Address Book](#)

Deposit rules used: Newberry EAD
Deposit requested by: Tracy Seneca
Deposit requested: 12/03/2014 4:17 a.m.

Deposited: 169
Deposit Failed: 0

Log files have been created for any records that were not successfully uploaded.
Contact the Portal Manager at [\[redacted\]](#) for help if the error message in the log is not clear.

Errors may be due to unclosed XML tags, character encoding issues, or element tags and values using invalid characters, such as ':'. You will need to edit the XML file(s) and resubmit them.

Email Confirmation

- Overview
- Deposit
- Tag
- Connect
- Preview
- Publish
- Search & Browse
- User Guide

Overview

Newberry Library

Metadata Hopper lets you deposit content to the Chicago Collections Consortium portal, control how your content is discovered in the portal, and connect related content in the portal. If you need help getting started, use the Quick Help and Tips text in the right-hand sidebar.

Your Content

Profile	Deposited	Previewed	Published
Daily Life Along the CB&Q	199	0	0
Newberry EAD	169	0	0

Your Chicago Collections Consortium Users

Administrator: No Admin
Archivists: 0

Quick Help

- Quick Start
- Demo Videos
- FAQ

Tips

- Choose [Deposit & Update](#) to add new or re-deposit content
- Choose [Tag](#) to control where your objects appear in the portal
- Choose [Connect](#) to connect related objects
- Choose [Preview](#) to see what your new content will look like in the portal
- Choose [Publish](#) to make new content available in the public portal
- Use [Search](#) to take any of these actions with a particular object or set of objects

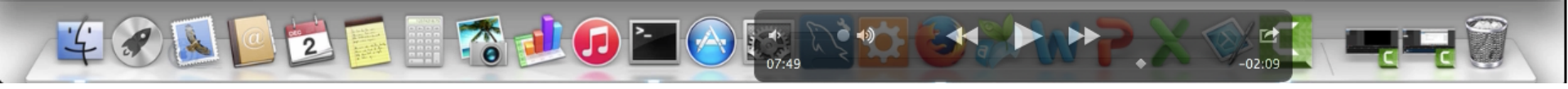

- Overview
- Deposit
- Tag**
- Connect
- Preview
- Publish
- Search & Browse
- User Guide

Tag

Use the dropdown to view a list of objects with selected tags.
You can also use the dropdown to remove tags from all objects with the selected tag.

Select status Select type

Browse by Tags Browse by Original Metadata

- Chicago Topics (299)
- Cities (254)
- Neighborhoods (3)

Quick Help

- Quick Start
- Demo Videos
- FAQ

Tips

Browse by Tags refers to tags added both automatically and manually to an object.

Use **Browse by Original Metadata** to browse by the metadata submitted with the object.



- Overview
- Deposit
- Tag
- Connect
- Preview
- Publish
- Search & Browse
- User Guide

23 results sort by value | count

Select All (on this page)

- Women (15 Records)
- Military And Wars (3 Records)
- Ecology And Government (2 Records)
- Police And Firefighters (1 Records)
- Printing History And Book Art (6 Records)
- Science And Technology (1 Records)
- Children And Teenagers (6 Records)
- Politics (4 Records)
- Business And Industry (4 Records)
- Music (2 Records)
- Medicine And Health (2 Records)
- Theater And Performing Arts (3 Records)
- Advertising And Publicity (3 Records)
- Education (8 Records)
- Clubs And Organization (3 Records)
- Design (7 Records)
- Journalism (6 Records)
- Literature And Poetry (6 Records)
- Architecture (1 Records)
- Transportation (201 Records)

- Quick Help
- Quick Start
 - Demo Videos
 - FAQ



Tagging: Individual Records

Newberry Library

EAD Finding Aid

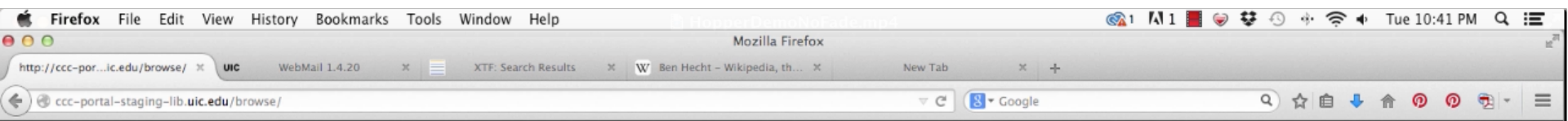

- Overview
- Deposit
- Tag
- Connect
- Preview
- Publish
- Search & Browse**
- User Guide

Search & Browse

Select status Select type

Search

Search all fields starts with contains Hecht

- Quick Help
- Quick Start
 - Demo Videos
 - FAQ



- Overview
- Deposit
- Tag
- Connect
- Preview
- Publish
- Search & Browse**
- User Guide

Results

Select status Select type Search all fields starts with contains Hecht Limit

Three results sort by value | count

Select All (on this page) Delete

- Inventory of the Henry Justin Smith Papers, 1914-1918
- Inventory of the Ben Hecht Papers, 1879-1983**
- Inventory of the Ben Hecht Filmscript Collection, 1935-1955

Inventory of the Ben Hecht Papers, 1879-1983

Local Identifier
Midwest MS Hecht

Description
Works, correspondence, and papers of novelist, playwright, and screenwriter Ben Hecht, and also papers of his wife Rose Caylor Hecht (novelist) and daughter Jenny Hecht (actress).

- ### Quick Help
- Quick Start
 - Demo Videos
 - FAQ



- Overview
- Deposit
- Tag
- Connect
- Preview
- Publish
- Search & Browse**
- User Guide

Object Record

Inventory of the Ben Hecht Papers, 1879-1983

Type Archival Collections: EAD
Status Imported
Tags Chicago ✕

[View Metadata](#) [Take Actions](#) [View History](#)

The following metadata was imported for this object. These terms will be indexed and searchable in the portal and will display in the detailed view of an object. Any corrections to you make to the object title will appear in the brief display of browse or search results. Both the corrected and original title will appear on the detailed display screen.

Title Inventory of the Ben Hecht Papers
Title (date) 1879-1983
Dates 1879-1983
Local identifier Midwest MS Hecht
Description Works, correspondence, and papers of novelist, playwright, and screenwriter Ben Hecht, and also papers of his wife Rose Caylor Hecht (novelist) and daughter Jenny Hecht (actress).
Names Weill, Kurt, 1900-1950
Names Wallace, Mike, 1918-
Names Sandburg, Carl, 1878-1967

- #### Quick Help
- Quick Start
 - Demo Videos
 - FAQ
- #### Tips
- Download an object's dc.xml file to review the Dublin Core metadata used for public browsing and searching.



- Overview
- Deposit
- Tag
- Connect
- Preview
- Publish
- Search & Browse**
- User Guide

Object Record

Inventory of the Ben Hecht Papers, 1879-1983

Type Archival Collections: EAD
Status Imported
Tags Chicago

- View Metadata**
- Take Actions
- View History

- [Add tags](#)
- [Add connections](#)
- [Delete record](#)
- [Update record](#)
- [Preview record](#)
- [Publish record](#)
- [Download dc.xml file](#)
- [Download original metadata file](#)

Quick Help

- [Quick Start](#)
- [Demo Videos](#)
- [FAQ](#)

Tips

Download an object's dc.xml file to review the Dublin Core metadata used for public browsing and searching.



- Overview
- Deposit
- Tag
- Connect
- Preview
- Publish
- Search & Browse
- User Guide

Add Tags

Inventory of the Ben Hecht Papers, 1879-1983

- Neighborhoods
- Cities
- Chicago Topics
- Names

- Photography
- Arts
- Architecture
- Fairs and Conventions
- Journalism
- Advertising and Publicity
- Anthropology
- Broadcasting
- Business and Industry
- Clubs and Organization
- Children and Teenagers
- City Planning
- Civil Planning
- Civil Engineering
- Crime and Criminals
- Design
- Diseases

Quick Help

- Quick Start
- Demo Videos
- FAQ



- Overview
- Deposit
- Tag
- Connect
- Preview
- Publish
- Search & Browse**
- User Guide

Object Record

Inventory of the Ben Hecht Papers, 1879-1983

Type Archival Collections: EAD
Status Imported
Tags Chicago x Journalism x Literature and Poetry x Theater and Performing Arts x

View Metadata [Take Actions](#) [View History](#)

The following metadata was imported for this object. These terms will be indexed and searchable in the portal and will display in the detailed view of an object. Any corrections to you make to the object title will appear in the brief display of browse or search results. Both the corrected and original title will appear on the detailed display screen.

Title Inventory of the Ben Hecht Papers
Title (date) 1879-1983
Dates 1879-1983
Local identifier Midwest MS Hecht
Description Works, correspondence, and papers of novelist, playwright, and screenwriter Ben Hecht, and also papers of his wife Rose Caylor Hecht (novelist) and daughter Jenny Hecht (actress).
Names Well, Kurt, 1900-1950
Names Wallace, Mike, 1918-
Names Sandburg, Carl, 1878-1967

- #### Quick Help
- Quick Start
 - Demo Videos
 - FAQ
- #### Tips
- Download an object's dc.xml file to review the Dublin Core metadata used for public browsing and searching.



The dc.xml File

Control of Front-End Browsing in XTF

- Overview
- Deposit
- Tag
- Connect
- Preview
- Publish
- Search & Browse**
- User Guide

Object Record

Inventory of the Ben Hecht Papers, 1879-1983

Type Archival Collections: EAD
Status Imported
Tags Chicago Journalism Literature and Poetry Theater and Performing Arts

[View Metadata](#) [Take Actions](#) [View History](#)

- Add tags
- Add connections
- Delete record
- Update record
- Preview record
- Publish record
- [Download dc.xml file](#)
- [Download original metadata file](#)

Quick Help

- Quick Start
- Demo Videos
- FAQ

Tips

Download an object's dc.xml file to review the Dublin Core metadata used for public browsing and searching.



App Explorer Project Explorer

- Local Filesystem
 - ccc-xtf (master)
 - xtf-ead-test

Outline Samples Snippets

type filter text

- dc
 - title : Title
 - identifier : PrimaryIdentifier
 - date : Date
 - identifier : LocalIdentifier
 - description : Description

```
1 <?xml version="1.0" ?>
2 <dc>
3   <title purpose="Title">Inventory of the Ben Hecht Papers, 1879-1983</title>
4   <identifier purpose="PrimaryIdentifier">3f63aca2-7aa3-11e4-bf9a-5254e6bba00</identifier>
5   <date purpose="Date">1879-1983</date>
6   <identifier purpose="LocalIdentifier">Midwest MS Hecht</identifier>
7   <description purpose="Description">Works, correspondence,
8     and papers of novelist, playwright, and screenwriter Ben Hecht, and also papers
9     of his wife Rose Caylor Hecht (novelist) and daughter Jenny Hecht (actress).</description>
10  <type purpose="Genre">Sound
11    recordings</type>
12  <type purpose="Genre">Screenplays</type>
13  <type purpose="Genre">Scrapbooks</type>
14  <type purpose="Genre">Photographs</type>
15  <type purpose="Genre">Moving images</type>
16  <type purpose="Genre">Clippings</type>
17  <type purpose="Genre">Artifacts</type>
18  <publisher purpose="InstitutionName">Newberry Library</publisher>
19  <publisher purpose="InstitutionURL">http://newberry.org</publisher>
20  <type purpose="EndUserFacetType">Archival Collections</type>
21  <format purpose="OriginalMetadataFormat">EAD</format>
22  <coverage purpose="City">Chicago</coverage>
23  <subject purpose="ChicagoTopic">Journalism</subject>
24  <subject purpose="ChicagoTopic">Literature and Poetry</subject>
25  <subject purpose="ChicagoTopic">Theater and Performing Arts</subject>
26 </dc>
27
```

Console Terminal Problems Search

No search results available. Start a search from the [search dialog...](#)

Updates Available [X]

Updates are available for your software. Click to review and install updates. Set up [Reminder options](#)

Writable Smart Insert Line: 1 Column: 1



Important to note

- Open source
- Entirely configurable!
 - You define the mapping forms
 - You can set the tag lists
 - You create the autotagging rules
 - You can customize the dc.xml file output

The Result?

Metadata Hopper Output

Browse by: All

Results: 1923 Items

Sorted by:

[Modify Search](#) | [New Search](#)

[Browse by Facet](#) | [Title](#) | [Author](#)

Page: 1 2 3 4 5 ... [Next](#)

Topic

- [Architecture](#) (265)
- [Transportation](#) (205)
- [Women](#) (166)
- [Politics](#) (140)
- [Ecology](#) (133)
- [Clubs and Organization](#) (101)
- [Ethnic and Cultural Groups](#) (92)
- [Design](#) (68)
- [Arts](#) (55)
- [Children and Teenagers](#) (44)

[more](#)

Neighborhood

- [Loop](#) (142)
- [Near West Side](#) (21)
- [Uptown](#) (21)
- [Near North Side](#) (15)
- [Kenwood](#) (6)
- [Near South Side](#) (4)
- [Woodlawn](#) (4)
- [Bridgeport](#) (1)
- [Lincoln Park](#) (1)
- [Pullman](#) (1)

[more](#)

Type

- [Archival Collections](#) (1042)
- [Digital Images](#) (881)

Library/Archive

- [University of Illinois at Chicago](#) (1115)
- [Newberry Library](#) (368)
- [University of Chicago](#) (331)
- [Art Institute of Chicago](#) (108)
- [Illinois Institute of Technology](#) (1)

Date

- ▣ [1950](#) (533)
- ▣ [1952](#) (531)
- ▣ [1951](#) (530)
- ▣ [1941](#) (528)
- ▣ [1945](#) (528)

[more](#)

Title: [World's Columbian Exposition Photographs by C.D. Arnold, 1891-1894](#)
Description: Nearly eight hundred large-format platinum photographic prints and twenty-five small-format sepia photographic prints by C.D. Arnold, the official photographer of the 1893 World's Columbian Exposition in Chicago, illustrate the development of fair's site and building construction, the fair while ope...
Date: 1894

Title: [Continental and Commercial National Bank Photographs Collection, c.1914](#)
Description: Black and white photographs of the Continental and Commercial National Bank in Chicago, Illinois, designed by D.H. Burnham and Company in 1912.
Date: 1914

Title: [Bevis, Mildred B., Notebook of Designs for the Kalo Shop, c.1910-1913](#)
Description: The notebook contains Arts and Crafts-influenced jewelry and tableware designs by Mildred Belle Bevis Hanks for the Kalo Shop in Chicago, Illinois.
Date: 1913

Title: [Adler, Dankmar, \(1844-1900\) Collection, 1844-1941](#)
Description: Papers and photographs related to the life and work of Chicago structural engineer Dankmar Adler, partner of architect Louis H. Sullivan.
Date: 1941
Subjects: [Architecture](#)

Title: [Khan, Fazlur, \(1929-1982\) Collection, 1944-1988](#)
Description: This collection holds professional papers and writings and a small group of personal papers of the Bangladeshi structural engineer Fazlur R. Khan.
Date: 1988
Subjects: [Design](#)

Title: [Weber, Peter J., \(1863-1923\) Papers, 1888-c.1945](#)
Description: Photographs, correspondence, and printed matter documenting a selection of German-American architect Peter J. Weber's built and unbuilt projects in the United States and abroad, though predominantly in the Chicago area. Projects represented in this collection span from his early years as a student a...
Date: 1922
Subjects: [Architecture](#)

Title: [Sailor, Homer Grant, \(1887-1968\) Papers, 1914-1993](#)
Description: Photographs and papers relating to the work of Chicago Prairie School architect Homer Grant Sailor.
Date: 1993
Subjects: [Architecture](#) | [Design](#)

Metadata Hopper Output

Search: **Transportation** in subject [X]
Digital Images in type [X]

[Modify Search](#) | [New Search](#)

Results: 199 Items

Browse by [Facet](#) | [Title](#) | [Author](#)

Sorted by:

Page: [1](#) [2](#) [3](#) [4](#) [5](#) ... [Next](#)

Topic

- [less](#)
- [Children and Teenagers](#) (2)
- [Families](#) (1)
- [Transportation](#) [X]
- [Women](#) (3)

Type

- [Digital Images](#) [X]

Library/Archive

- [Newberry Library](#) (199)

Date

- [1948](#) (199)
- [01](#) (199)
- [1905](#) (198)
- [1906](#) (1)



Title: [Armature repair department of Diesel shop](#)
Description: Three workmen repairing armatures for diesel engines
Date: 1905
Subjects: [Transportation](#)



Title: [Union Station—view of concourse showing information desk](#)
Description: Women and men clustered around the information desk. In the foreground are two servicemen, bags at their feet, dealing with papers in their hands. List of arriving trains shown above the information desk.
Date: 1905
Subjects: [Transportation](#)



Title: [Filling journal boxes with oil at car repair tracks](#)
Description: Man filling journal boxes with oil at car repair tracks
Date: 1905
Subjects: [Transportation](#)



Title: [Commuters waiting for suburban train](#)
Description: Man folding a newspaper while standing on a train platform. Other people are visible on the platform. There is a train in the distance under a signal tower (?), apparently coming into the station. Parked cars are visible near the station itself.
Date: 1905
Subjects: [Transportation](#)

Metadata Hopper Output

Search: **Fairs and Conventions** in **subject** [X]
Near South Side in **neighborhood** [X]

[Modify Search](#) | [New Search](#)

Results: 3 Items

[Browse by Facet](#) | [Title](#) | [Author](#)

Sorted by:

Page: 1

- Topic**
- [less](#)
 - [Advertising and Publicity](#) (1)
 - [Architecture](#) (3)
 - [Business and Industry](#) (1)
 - [Fairs and Conventions](#) [X]
 - [Printing History and Book Art](#) (1)
 - [Sports and Recreation](#) (1)
- Neighborhood**
- [Near South Side](#) [X]
- Type**
- [Digital Images](#) (2)
 - [Archival Collections](#) (1)
- Library/Archive**
- [Art Institute of Chicago](#) (2)
 - [University of Chicago](#) (1)
- Date**
- [1932](#) (3)



Title: [Century of Progress International Exposition, General Motors Building](#)

Description:

Date: 1933

Subjects: [Architecture](#) | [Fairs and Conventions](#)



Title: [Century of Progress International Exposition, General Exhibits Group](#)

Description:

Date: 1933

Subjects: [Architecture](#) | [Fairs and Conventions](#)

Title: [Guide to the R.R. Donnelley & Sons Company Archive, 1844-2005](#)

Description: Founded in Chicago in 1864 by Canadian immigrant Richard Robert Donnelley, R.R. Donnelley & Sons Company is a leading global provider of printing and print-related services. The archive contains business records, product samples and promotional material, biographical files and personal papers, histo...

Date: 2005

Subjects: [Architecture](#) | [Fairs and Conventions](#) | [Advertising and Publicity](#) | [Business and Industry](#) | [Printing History and Book Art](#) | [Sports and Recreation](#)

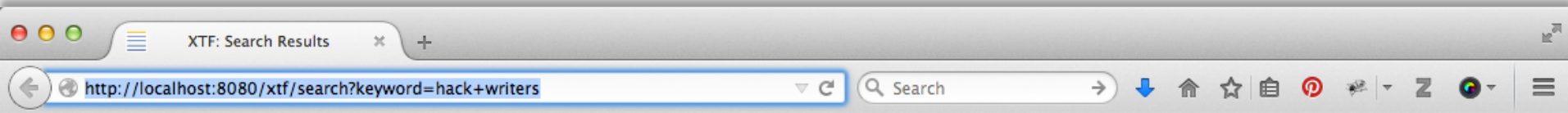

Metadata Hopper Output

Search: **hack** and **writers** in keywords [X]

[Modify Search](#) | [New Search](#)

Results: 1 Item

Browse by [Facet](#) | [Title](#) | [Author](#)

Sorted by:

Page: 1

- Topic**
 - [Literature and Poetry](#) (1)
- Neighborhood**
- Type**
 - [Archival Collections](#) (1)
- Library/Archive**
 - [Newberry Library](#) (1)
- Date**
 - [1880](#) (1)
 - [1881](#) (1)
 - [1882](#) (1)
 - [1883](#) (1)
 - [1884](#) (1)
 - [more](#)

Title: [Inventory of the Henry Kitchell Webster Papers, 1880-1932, bulk 1900-1932](#)

Description: Correspondence and drafts and typescripts of works of Illinois novelist and short story writer, Henry Kitchell Webster, an Evanston native who had a highly successful literary career in the early decades of the twentieth century. Includes examples of the range of Webster's published ...

Date: 1932

Subjects: [Literature and Poetry](#)

Matches: ...United States **Hack writers** Novelists, American --...
1 hit

[Comments?](#) | [Questions?](#) | [Choose Language](#)

Thank you!!

And thanks to:

- Andrew W. Mellon Foundation
- Kate Flynn, CCC Portal Manager
- Esther Verreanu, Lead Developer
- Allan Berry, CCC Developer
- CCC Portal Committee Members
- Jaclyn Grahl, CCC Executive Director

chicagocollectionsconsortium.org